

# G5.1

## "CUTTY" VEGETABLE CUTTER



■  
30+ servings  
per day

■  
Gastronomy

■  
Hotels

■  
Catering  
services

■  
Party services

■  
Diet kitchens

- XXL filling chute for bulky vegetables
- Diagonal cutting
- Practical space for 1/1 GN-containers
- Basic unit and components made of stainless steel
- Infinitely variable speed control
- Basic carrier disc
- Removable dishwasher suitable functional components

## FUNCTIONAL DETAILS



Basic unit made of stainless steel



1 Easy cleaning by removal of the cutting lid, dishwasher-safe



2 Filler necks for elongated material (dia. 61 mm)

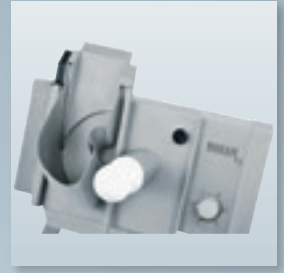

3 XXL filling chute as depot for processing large volumes in one step (Cross-sectional area 173 cm<sup>2</sup>)

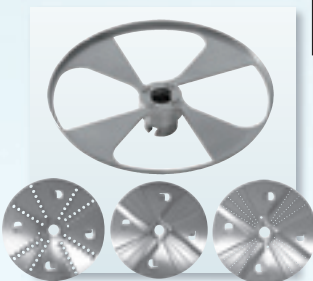
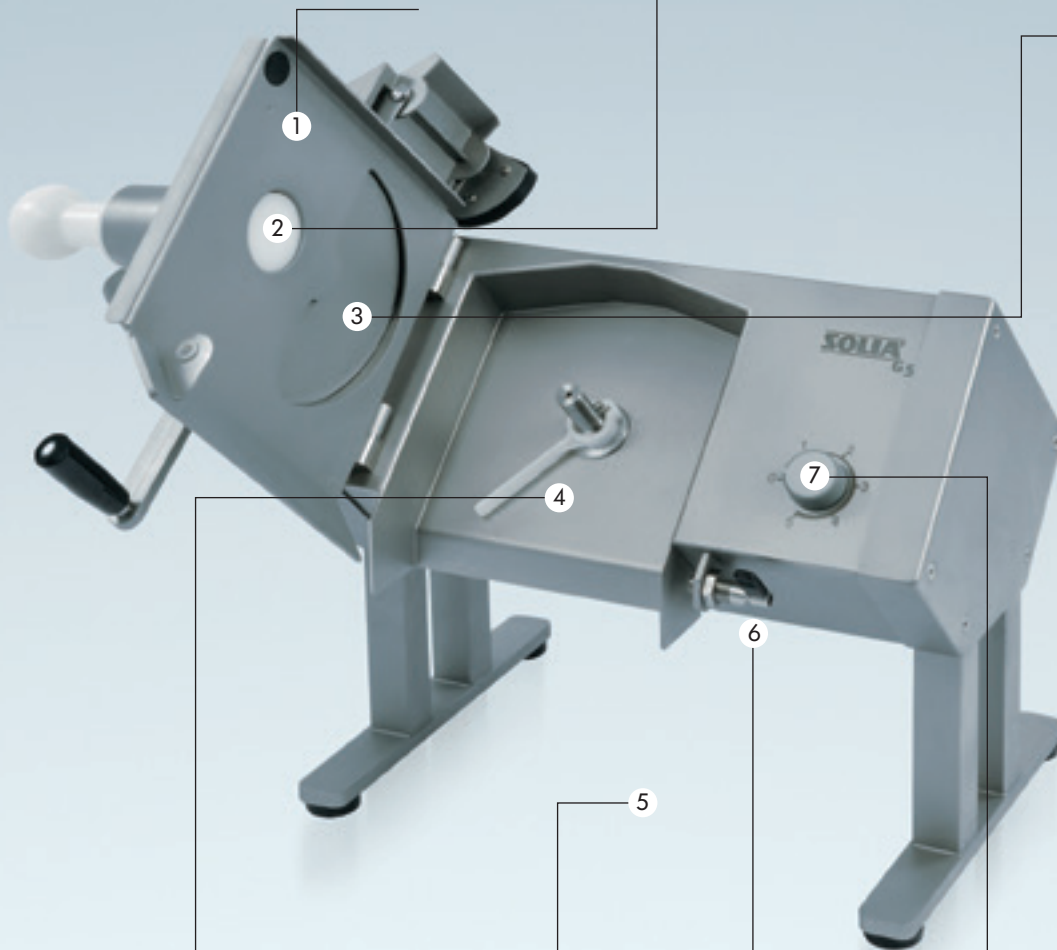

4 Basik carrier disc



5 Space for 1/1 GN-containers (150 mm high)



6 Safety catch at the side to latch the filler flap in place



7 Infinitely variable setting from 130 to 360 rpm

## CUTTING DISCS AND ACCESSORIES



Diagonal cutting hopper with safety switch-off and pusher, to be placed on the feed chute  
105 070 020

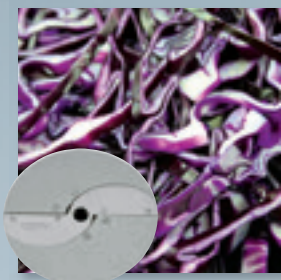

Curved blade disc, stainless steel, double-bladed, adjustable  
0-5 mm 561 000 0352\*

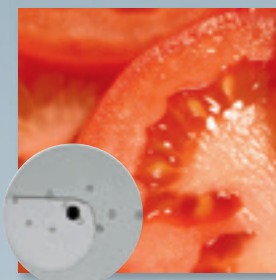

Curved blade disc, stainless steel, single-bladed, adjustable  
0-10 mm 103 275 000



Crescent blade discs, stainless steel  
3 mm 561 000 0363  
4 mm 561 000 0360\*  
6 mm 561 000 0361



Strip cutting discs, stainless steel  
2 x 2 mm Juliennes 561 000 0362\*  
4 x 4 mm Juliennes 561 000 0364  
6 x 6 mm 561 000 0366  
8 x 8 mm 561 000 0368

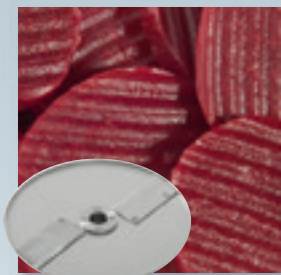

Crinkle cutting discs, stainless steel  
4 mm 561 000 0369  
6 mm 568 000 0367

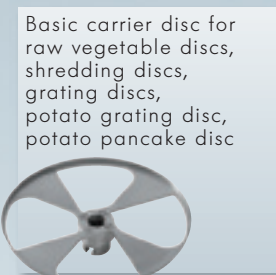

Basic carrier disc for raw vegetable discs, shredding discs, grating discs, potato grating disc, potato pancake disc

Basic carrier disc, stainless steel  
568 000 0370\*

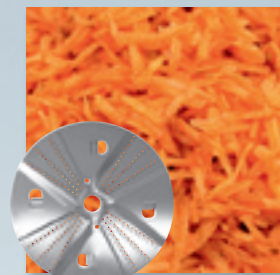

Raw vegetable discs, stainless steel, hand sharpened  
2 mm 561 000 0380  
2.5 mm 561 000 0382  
3 mm 561 000 0371\*  
4 mm 561 000 0374

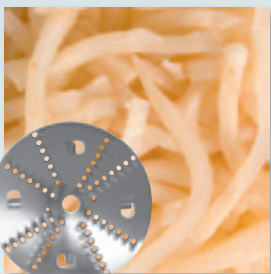

Shredding discs, stainless steel, hand sharpened  
6 mm 561 000 0372\*  
9 mm 561 000 0373

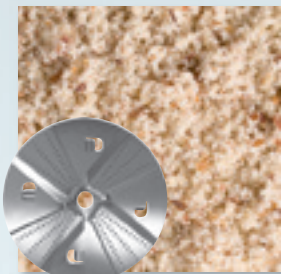

Grating discs, stainless steel  
2 mm 561 000 0381  
3 mm 561 000 0375  
4 mm 561 000 0378

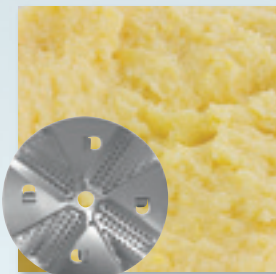

Potato grating disc, stainless steel, crown-toothed  
561 000 0376



Potato pancake disc, stainless steel, partly crown-toothed, combination of 376/380  
561 000 0377



Dicer, complete stainless steel  
4 x 4 x 5 mm 105 040 100  
5.5 x 5.5 x 5 mm 105 043 100  
8 x 8 x 10 mm 105 046 100  
11 x 11 x 10 mm 105 049 100\*  
16 x 16 x 10 mm 105 052 100  
22 x 22 x 10 mm 105 055 100



Protective hand grip for dicer disc  
105 040 190

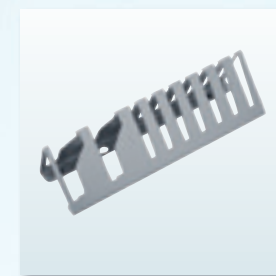

Multi disc rack, stainless steel, for 2 discs and 7 exchange discs  
561 000 0191\*



Disc rack, stainless steel, for 5 discs  
561 000 0190

## TECHNICAL DATA

|   |  |
|---|--|
| Power supply                            | 230 V, 50 Hz<br>2.5 m cable with CEE Euro plug |
| Output (kW)                             | 0.37   |
| Fuse protection (A)                     | 16   |
| Ingress protection                      | IP 54 (splash-proofed)                         |
| Infinitely variable speed control (rpm) | 130-360 (variable)                             |
| Dimensions (L x W x H)                  | 475 x 425 x 520 mm (max. 830 mm)               |
| Weight (kg)                             | 28   |

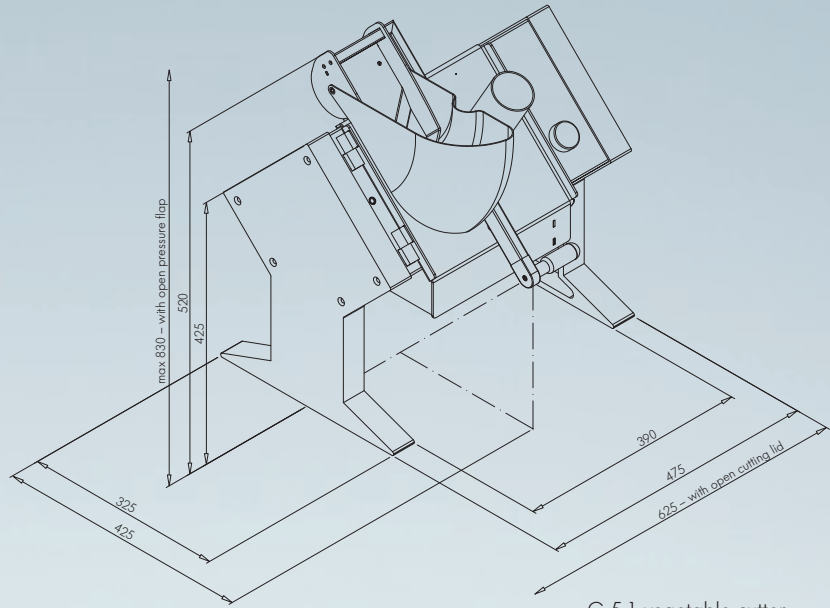

G 5.1 vegetable cutter  
(Representation)

## PROCESSING CAPACITY

| Description                           | Use  | Throughput** |
|---------------------------------------|--|--------------|
| Curved blade disc, double-bladed      | Cutting of vegetables  | 50-200 kg/h  |
| Curved blade disc, single-bladed      | Cutting of soft vegetables                                       | 50-100 kg/h  |
| Crescent blade discs, stainless steel | Cutting of boiled potatoes, leek and mushrooms                   | 80-150 kg/h  |
| Shredding discs                       | Shredding of eg. celery, radish, potatoes, carrots, gouda cheese | 120-200 kg/h |
| Grating discs                         | Grating e.g. bread, nuts, almonds, chocolates, cheese            | 50-120 kg/h  |
| Potato grating disc                   | Grating e.g. potatoes, parmesan cheese                           | 50 kg/h      |
| Potato pancake disc                   | Grating e.g. potatoes  | 50 kg/h      |
| Dicer                                 | Dicing of vegetables, fruits                                     | 120-200 kg/h |

\*\*The throughputs are dependent on cutting thickness and product.

The figures shown here are for illustration only and may deviate from the actual design version. Technical alterations are reserved. For additional accessories please refer to our price list.